

# FLORENCE

≡ CORPORATION

**AUTHENTIC  
PARTS**

[www.authenticparts.com](http://www.authenticparts.com)  
1-800-229-AUTH (2884)



2018 Product Catalog Booklet

## Replacement Mailbox Products

Horizontal & Vertical Mailboxes



# Replacement Mailboxes

## *Horizontal and Vertical Units*



Florence has been designing and manufacturing mailboxes for centralized delivery since 1934 and is proud to continue building its horizontal and vertical mailboxes for your postal replacement and private delivery applications.

Postal Delivery is when the USPS Letter Carrier delivers mail to each existing tenant compartment in a mailbox installation, while private delivery is when the letter carrier simply drops all the mail at one location and another entrusted individual places it into all the individual tenant compartments - most commonly used in university and military housing settings.

Mailboxes for private delivery do not have to conform to current postal regulations and therefore often vary in size and installation requirements from standard USPS Approved equipment.

Due to changes in postal regulations, these older style horizontal and vertical mailboxes may now only be used to replace a current installation of similar mailboxes when no modification of the existing wall opening will be made. However, if the rough opening dimensions will be changed during a replacement or remodel, or the install is for new construction, STD-4C equipment will be required (*see pages 12 - 29 for product details*).





Vertical mailboxes come in five standard sizes and easily slip into the opening vacated by an older box; however, it is highly recommended that existing vertical mailboxes be upgraded to either a CBU or STD-4C to ensure proper security. As mail is loaded from the top of these vertical units, it makes them vulnerable to the weather so they should be used indoors only.

Horizontal mailboxes are an economical solution for your private centralized mail delivery needs when a large number of mailboxes are needed within a limited amount of indoor wall space. As these mailboxes were designed to meet

specifications which are 30+ years old, they should be protected from the weather and only installed indoors as they do not include the same weather resistant features or security features as the STD-4C mail equipment of today.

To quickly and easily design your horizontal mailbox installation, Florence has developed an easy-to-use Revit mailbox configurator which is unique to the industry. This do-it-yourself online tool offers both a wizard mode featuring all standard modules for novices, and an advanced power mode for those that want to upgrade their installation with optional features and door sizes.



Mount these horizontal mailboxes in large banks, or on multiple walls.



Vertical mailboxes have top-loading tall, skinny compartments.

# 1400 Series - Standard

## for Postal Delivery



 [florencemailboxes.com/horizontal](http://florencemailboxes.com/horizontal)

As an indoor solution, these traditional-style mailboxes are most popular in apartment complexes, and university/military housing. The standard for decades, these are available as replacement units for worn out installations. (All new construction must use the postal approved STD-4C mailboxes, see page 30 for details.)

### Standard Features

- Front-load
- Recess-mounted
- Prepared for USPS installed Master Lock
- Anodized aluminum finish
- 5-pin cylinder tenant cam lock with two keys (1,000 key changes) see page 40
- Snap-on outer trim kit (available by request)
- Clear plastic number slots or engraved numbers

### Door Sizes

Standard horizontal mailboxes are pre-configured with the following door sizes:

#### Tenant Compartments

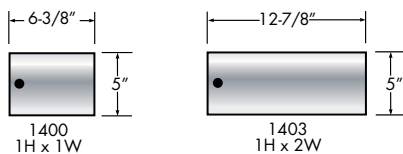

#### Collection Compartment

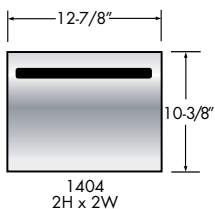

#### Parcel Locker Compartments

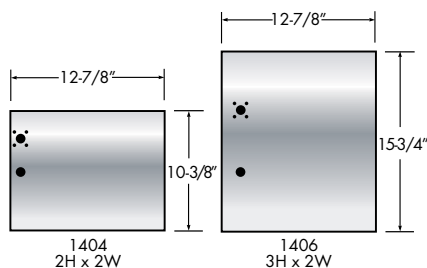

#### Plastic Number Slot:

Number slots are 5/8" H x 2" W. (Available on tenant compartment doors only.)

**Engraving:** Custom engraving utilizes the USPS Standard *US Block* font and is 3/4" tall. All engraving can include up to 5 characters in one line per door.

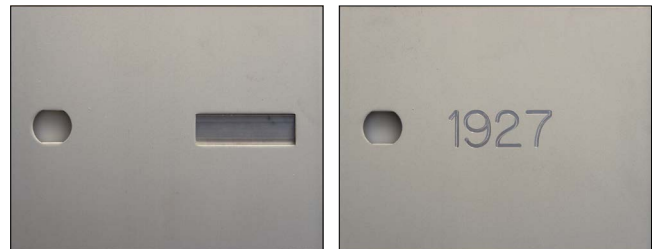

If your installation needs a little more customization than available on the standard 1400 series, select the custom 1400 series to swap doors and lock types. See pages 40 - 41 for details.

Note: Horizontal mailbox installations should be protected from direct exposure to the weather; Florence is not responsible for damage caused by weather conditions as these products are rated for indoor use only.

# Horizontal Mailboxes

## 5 DOORS HIGH Actual: 28" H / Rough Opening: 28-1/4" H

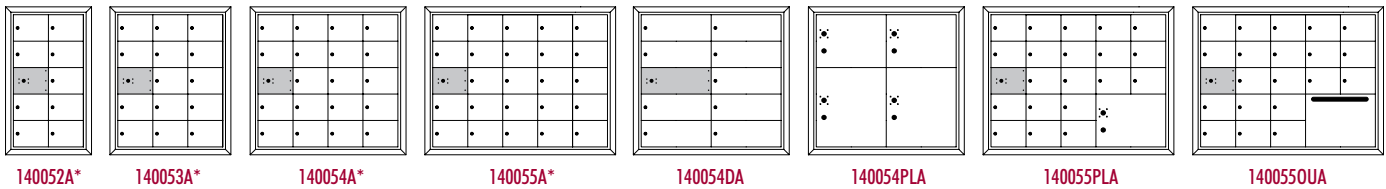

Model	140052A*	140053A*	140054A*	140055A*	140054DA	140054PLA	140055PLA	1400550UA
# Mailboxes (Total)	9	14	19	24	9	0	20	20
# Parcel Lockers (Total)	0	0	0	0	0	4	1	0
# Collection	0	0	0	0	0	0	0	1
Actual Width	14-3/8"	20-3/4"	27-1/4"	33-5/8"	27-1/4"	27-1/4"	33-5/8"	33-5/8"
Rough Opening Width	14-5/8"	21"	27-1/2"	33-7/8"	27-1/2"	27-1/2"	33-7/8"	33-7/8"

## 6 DOORS HIGH Actual: 33-3/8" H / Rough Opening: 33-5/8" H

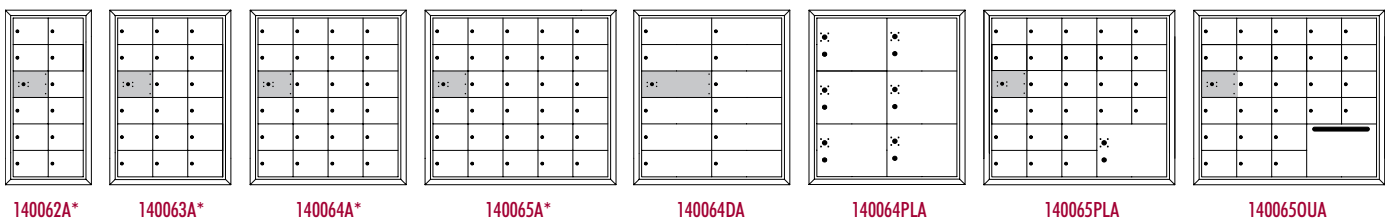

Model	140062A*	140063A*	140064A*	140065A*	140064DA	140064PLA	140065PLA	1400650UA
# Mailboxes (Total)	11	17	23	29	11	0	25	25
# Parcel Lockers (Total)	0	0	0	0	0	6	1	0
# Collection	0	0	0	0	0	0	0	1
Actual Width	14-3/8"	20-3/4"	27-1/4"	33-5/8"	27-1/4"	27-1/4"	33-5/8"	33-5/8"
Rough Opening Width	14-5/8"	21"	27-1/2"	33-7/8"	27-1/2"	27-1/2"	33-7/8"	33-7/8"

## 7 DOORS HIGH Actual: 38-3/4" H / Rough Opening: 39" H

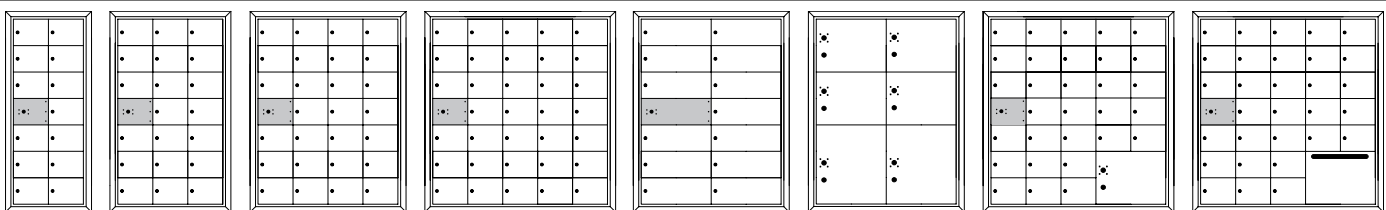

Model	140072A*	140073A*	140074A*	140075A*	140074DA	140074PLA	140075PLA	1400750UA
# Mailboxes (Total)	13	20	27	34	13	0	30	30
# Parcel Lockers (Total)	0	0	0	0	0	6	1	0
# Collection	0	0	0	0	0	0	0	1
Actual Width	14-3/8"	20-3/4"	27-1/4"	33-5/8"	27-1/4"	27-1/4"	33-5/8"	33-5/8"
Rough Opening Width	14-5/8"	21"	27-1/2"	33-7/8"	27-1/2"	27-1/2"	33-7/8"	33-7/8"

### NOTES:

Standard modules noted with an asterisk (\*) are fully configurable; visit [florencemailboxes.com/configure](http://florencemailboxes.com/configure) to quickly and easily create your custom solution.

See pages 40-41 for compartment size definitions and configurable options.

All model numbers listed are for standard front-load modules; add -SP for custom modules at the end of the number.



# 1400 Series - Custom

## for Postal or Private Delivery



Providing an opportunity for greater flexibility in door size and type selection, the Florence 1400 Custom Series allows you to upgrade your horizontal mailboxes to fit your installation needs. This configurable solution lets you be the designer as you place the doors where you want them instead of being tied to a pre-determined standard module (see door size chart on opposite page for options).

 [florencemailboxes.com/configure](http://florencemailboxes.com/configure)



**Note:** Horizontal mailbox installations should be protected from direct exposure to the weather; Florence is not responsible for damage caused by weather conditions as these products are rated for indoor use only.

### Optional Features

- Private master lock
- Eight powder coat color finishes
- Combination lock (for private services only)
- Configurable door sizes and layout options

### Lock Selections

Cam-lock is USPS Approved and standard on all horizontal mailboxes. Lock comes with two keys (1,000 key changes). Combination lock option for Private Delivery only.

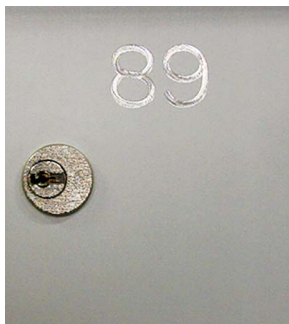

*For lock maintenance, only graphite type lubricants are recommended on product locks. For additional assistance with locks, contact your local locksmith.*

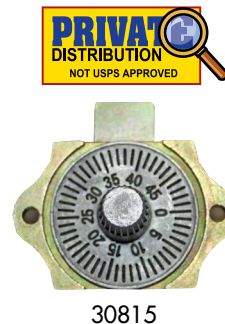

### Color Options

**Anodized Aluminum is standard for all horizontal mailboxes. Upgrade your installation to one of eight different architectural color options, all in a durable, powder coat finish.**

*Colors shown are representative of the actual powder coat finish but are limited by printing conditions and may vary slightly from finished product.*

<b>Antique Bronze (AB)</b> PMS 8622C	<b>Black (BK)</b> PMS Black 6C	<b>Dark Bronze (DB)</b> PMS Black 7C	<b>Gold Speck (GS)</b> PMS 7-5C
<b>Postal Grey (PG)</b> PMS 413C	<b>Sandstone (SD)</b> PMS 7501C	<b>Silver Speck (SS)</b> PMS 877C	<b>White (WH)</b> PMS White

## Configurable Modules



Sometimes a standard sized compartment is simply not big enough to suit your residents' needs. That's why you can change mail compartment sizes or add as many collection and/or parcel lockers as your installation requires. Simply begin with an all tenant standard module found on page 39, and modify it by placing any of the various door sizes and types found in the chart below.

To quickly design your custom horizontal mailbox installation, Florence has developed an easy-to-use Revit mailbox configurator which is unique to the industry. This do-it-yourself online tool provides the opportunity for you to place the doors not only where you want them, but with as many as you want. So go ahead, add two collection boxes - one for rent, one for mail in your design; it's your mailbox!

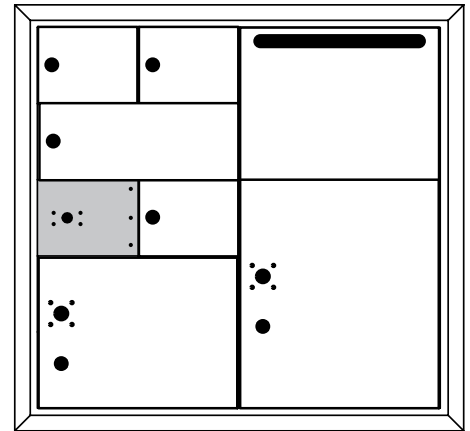

Our configurator tool does the math for you, provides a drawing and even allows you to submit your creation for quote!

## Door Sizes

Configurable units available in cabinet sizes 2 - 5 Wide and 5 - 7 High.

### Tenant Compartments

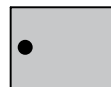

NOTE: Tenant compartment ID options include plastic number slot or engraving.

### Collection Compartments



NOTE: Collection compartments are available with or without an access lock and can be engraved.

### Parcel Locker Compartments

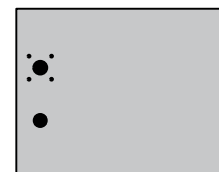

NOTE: Parcel locker ID options includes engraving. See page 38 for details.

**1400**  
One-High, One-Wide  
(5" H x 6-3/8" W)



**1403**  
One-High, Two-Wide  
(5" H x 12-7/8" W)



**1404**  
Two-High, Two-Wide  
(10-3/8" H x 12-7/8" W)

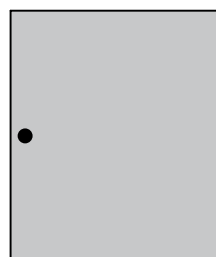

**1406**  
Three-High, Two-Wide  
(15-3/4" H x 12-7/8" W)

# 1600/1700 Series - Standard

*for Private Delivery*



A favorite of University housing managers, this indoor solution helps keep your mail area organized. Available in front-loading (1600 series) or rear-loading (1700 series) units, each module provides a lot of compartments in a small space. Since these are private delivery mailboxes, they are not constrained by postal installation regulations and therefore have no minimum or maximum mounting height requirements.

## Standard Features

- Recess-mounted
- Anodized aluminum finish
- 5-pin cylinder tenant cam lock with two keys (1,000 key changes) see page 46
- Snap-on outer trim kit (available by request)
- Clear plastic number slots or engraved numbers

**Rear-load mailboxes (1700 series)** have an exposed back for easy distribution, so keep in mind during planning that additional space will be necessary for a secure room behind the installation. Access to the room may be restricted and easily accessed using a key keeper (see page 52) with a private lock.

### Plastic Number Slot:

Number slots are 5/8"H x 2"W. (Available on tenant compartment doors only.)

**Engraving:** Custom engraving utilizes the USPS Standard *US Block* font and is 3/4" tall. All engraving can include up to 5 characters on one line per door.



**Door Size:** All standard units contain one door size. If you need more than the standard configurations shown on pages 43-45, our easy-to-use online configurator allows you to complete your project from the full range of size options - see page 47 for details.

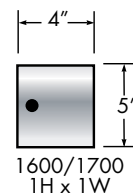



# Horizontal Mailboxes

## 7 DOORS HIGH Actual: 38-3/4"H / Rough Opening: 39"H

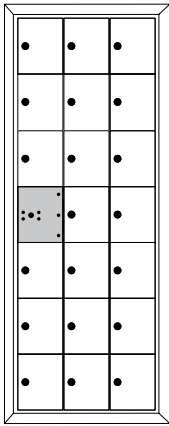

160073A

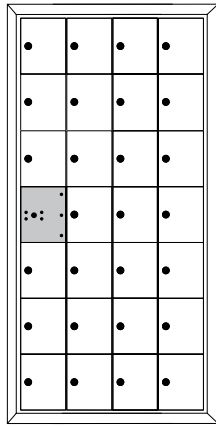

160074A

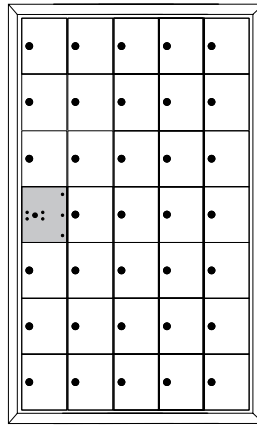

160075A

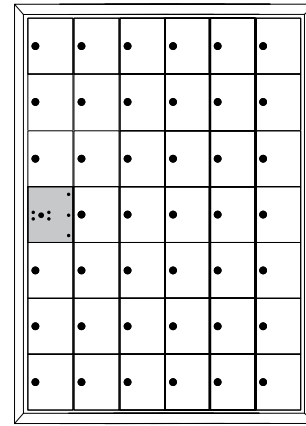

160076A

Model	160073A	160074A	160075A	160076A
# Mailboxes (Max)	20	27	34	41
Actual Width	13-3/4"	17-13/16"	21-7/8"	25-15/16"
Rough Opening Width	14"	18-1/16"	22-1/8"	26-3/16"

## 8 DOORS HIGH Actual: 44-3/16"H / Rough Opening: 44-7/16"H

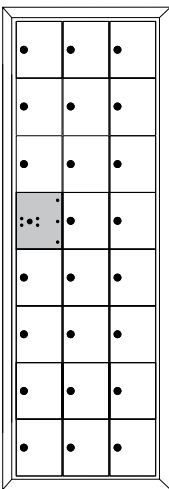

160083A

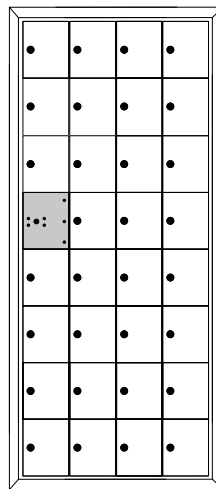

160084A

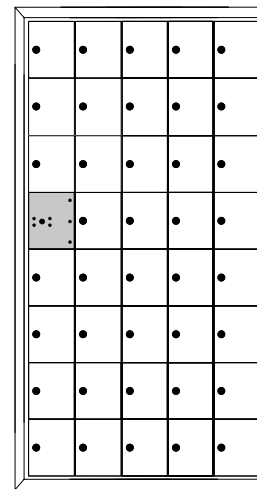

160085A

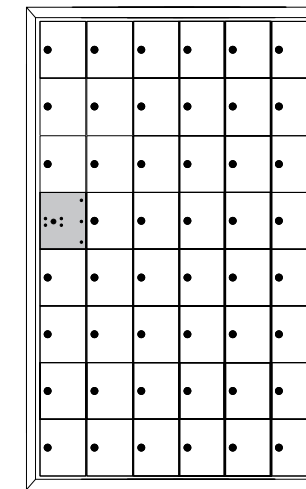

160086A

Model	160083A	160084A	160085A	160086A
# Mailboxes (Max)	23	31	39	47
Actual Width	13-3/4"	17-13/16"	21-7/8"	25-15/16"
Rough Opening Width	14"	18-1/16"	22-1/8"	26-3/16"

### NOTES:

All standard horizontal mailbox modules shown above are also available in rear-load.

All model numbers listed are for front-load modules; change the first four numbers from 1600 to 1700 for rear-load modules and increase the max number of mailboxes by one.

## 9 DOORS HIGH Actual: 49-9/16" H / Rough Opening: 49-13/16" H

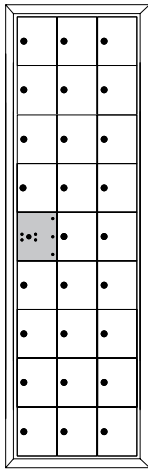

160093A

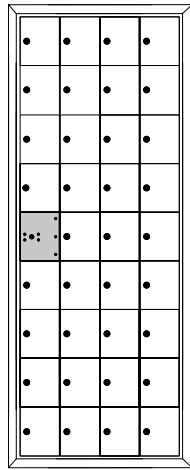

160094A

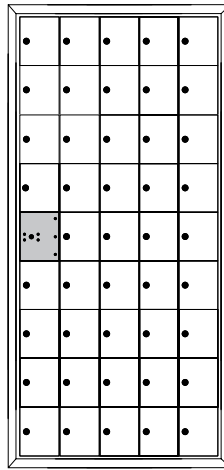

160095A

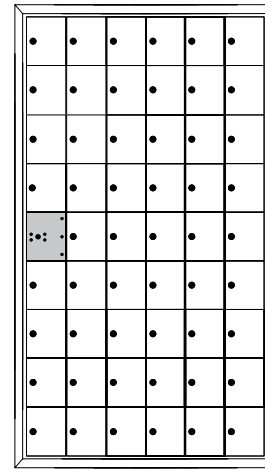

160096A

Model	160093A	160094A	160095A	160096A
# Mailboxes (Max)	26	35	44	53
Actual Width	13-3/4"	17-13/16"	21-7/8"	25-15/16"
Rough Opening Width	14"	18-1/16"	22-1/8"	26-3/16"

## 11 DOORS HIGH Actual: 60-3/8" H / Rough Opening: 60-5/8" H

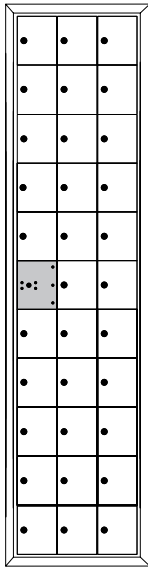

1600113A

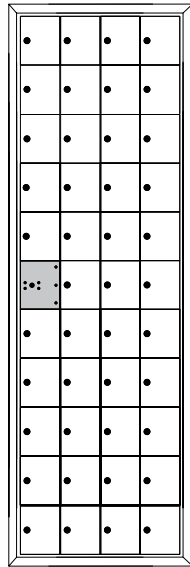

1600114A

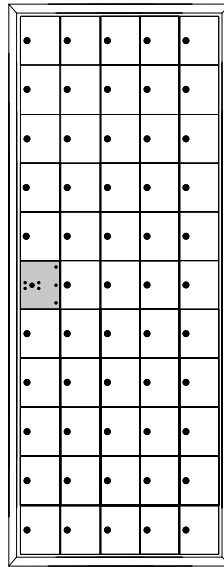

1600115A

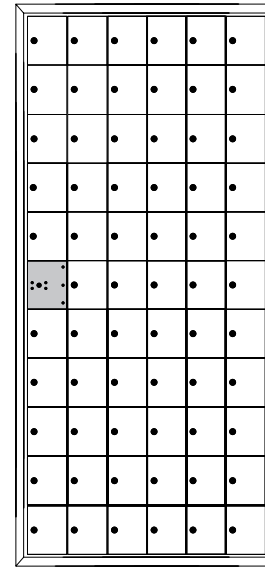

1600116A

Model	1600113A	1600114A	1600115A	1600116A
# Mailboxes (Max)	32	43	54	65
Actual Width	13-3/4"	17-13/16"	21-7/8"	25-15/16"
Rough Opening Width	14"	18-1/16"	22-1/8"	26-3/16"

**NOTES:**

All standard horizontal mailbox modules shown are also available in rear-load.

All model numbers listed are for front-load modules; change the first four numbers from 1600 to 1700 for rear-load modules and increase the max number of mailboxes by one.

# Horizontal Mailboxes

## 10 DOORS HIGH Actual: 55"H / Rough Opening: 55-1/4"H

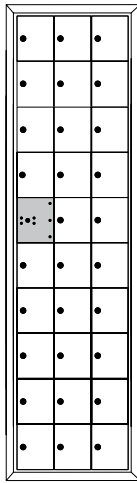

1600103A

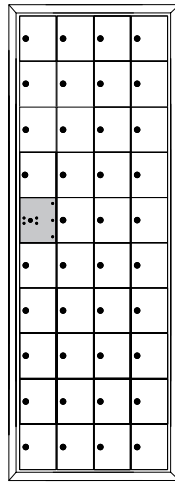

1600104A

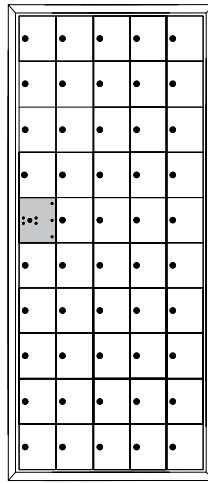

1600105A

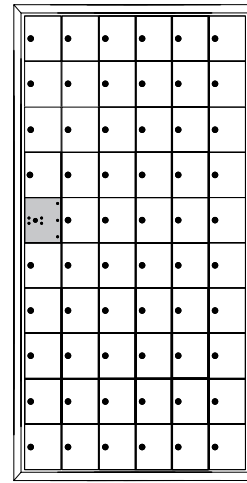

1600106A

Model	1600103A	1600104A	1600105A	1600106A
# Mailboxes (Max)	29	39	49	59
Actual Width	13-3/4"	17-13/16"	21-7/8"	25-15/16"
Rough Opening Width	14"	18-1/16"	22-1/8"	26-3/16"

## 12 DOORS HIGH Actual: 65-13/16"H / Rough Opening: 66-1/16"H

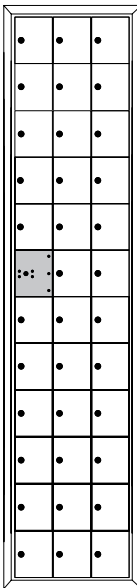

1600123A

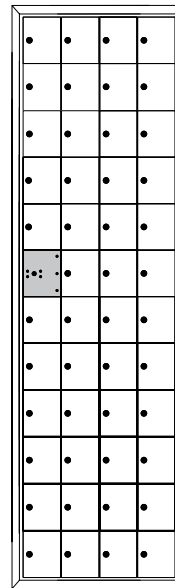

1600124A

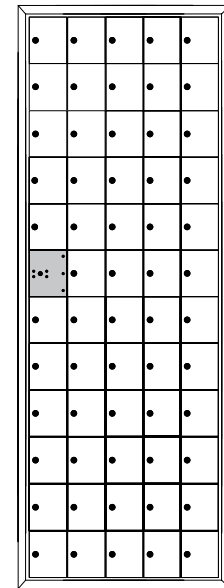

1600125A

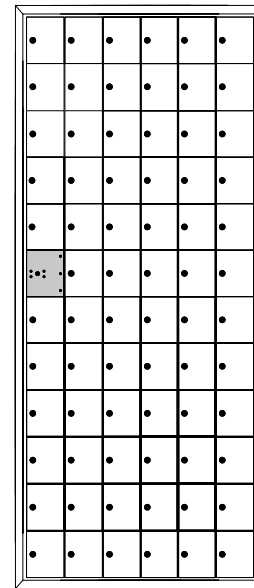

1600126A

Model	1600123A	1600124A	1600125A	1600126A
# Mailboxes (Max)	35	47	59	71
Actual Width	13-3/4"	17-13/16"	21-7/8"	25-15/16"
Rough Opening Width	14"	18-1/16"	22-1/8"	26-3/16"

**NOTES:**

All standard horizontal mailbox modules shown are also available in rear-load.

All model numbers listed are for front-load modules; change the first four numbers from 1600 to 1700 for rear-load modules and increase the max number of mailboxes by one.



# 1600/1700 Series - Custom

## for Private Delivery



Sometimes a standard sized compartment is simply not big enough to suit your residents' needs. That's why you can change mail compartment sizes or add as many collection and/or parcel lockers as your installation requires when you start with the custom all tenant compartment unit. These simple configurable options provide greater flexibility in door selection to ensure you can easily replace your current installation (see door size chart for options).

 [florencemailboxes.com/configure](http://florencemailboxes.com/configure)



**Note:** Horizontal mailbox installations should be protected from direct exposure to the weather; Florence is not responsible for damage caused by weather conditions as these products are rated for indoor use only.

### Optional Features

- Eight architectural powder coat color finishes
- Combination lock
- Hinged rear doors with private lock (for 1700)
- Configurable door sizes and layout options

### Lock Selections

Cam-lock is standard on all 1600/1700 horizontal mailboxes and comes with two keys (1,000 key changes). Combination lock option also available.



K30809

*For lock maintenance, only graphite type lubricants are recommended on product locks. For additional assistance with locks, contact your local locksmith.*

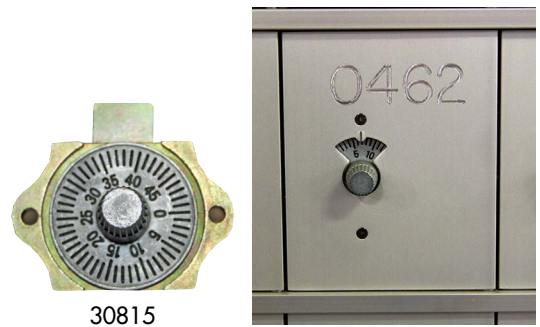

30815

### Color Options

**Anodized Aluminum is standard for all horizontal mailboxes. Upgrade your installation to one of eight different architectural color options, all in a durable, powder coat finish.**

*Colors shown are representative of the actual powder coat finish but are limited by printing conditions and may vary slightly from finished product.*

<b>Antique Bronze (AB)</b> PMS 8622C	<b>Black (BK)</b> PMS Black 6C	<b>Dark Bronze (DB)</b> PMS Black 7C	<b>Gold Speck (GS)</b> PMS 7-5C
<b>Postal Grey (PG)</b> PMS 413C	<b>Sandstone (SD)</b> PMS 7501C	<b>Silver Speck (SS)</b> PMS 877C	<b>White (WH)</b> PMS White

## Configurable Modules



Go beyond the standard and create your own custom mailbox!

To quickly design your custom horizontal mailbox installation, Florence has developed an easy-to-use mailbox configurator which is unique to the industry. This do-it-yourself online tool provides the opportunity for you to place the doors not only where you want them, but with as many as you want (see door options in chart below). Our configurator tool will do the math for you, provide a drawing, and even allows you to submit your unique creation for quote!

So go ahead and add multiple collection compartments - it's your design!

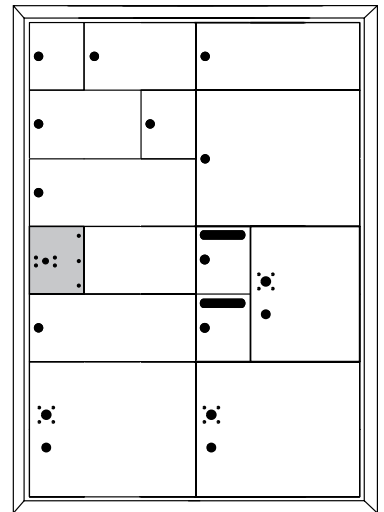

## Door Sizes

Configurable units available in cabinet sizes 3 - 6 Wide and 7 - 12 High.

**1600/1700**  
One-High, One-Wide  
(5" H x 4" W)

### Tenant Compartments

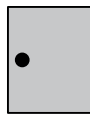

NOTE: Tenant compartment ID options include plastic number slot or engraving.

### Collection Compartments



NOTE: Collection compartments are available with or without an access lock and can be engraved.

### Parcel Locker Compartments

**1603/1703**  
One-High, Two-Wide  
(5" H x 8-1/16" W)

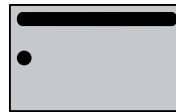

**1605/1705**  
One-High, Three-Wide  
(5" H x 12-1/8" W)



**1604/1704**  
Two-High, Two-Wide  
(10-3/8" H x 8-1/16" W)

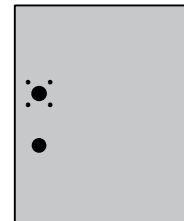
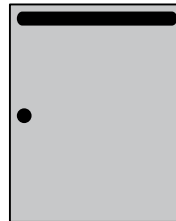
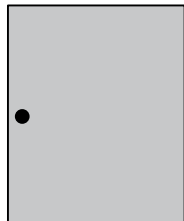

NOTE: Parcel locker ID options includes engraving. See page 42 for details.

**1607/1707**  
Two-High, Three-Wide  
(10-3/8" H x 12-1/8" W)

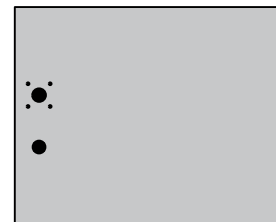
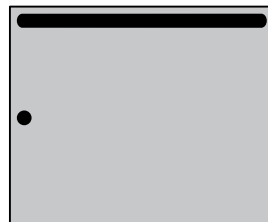

# 1250 Vertical Mailboxes

*for Postal Delivery*

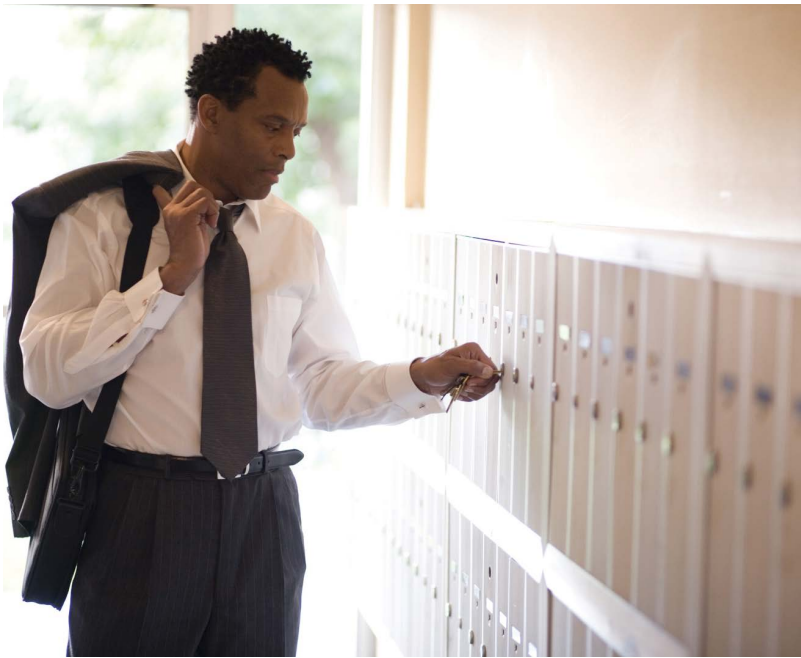

Vertical mailboxes have been a staple for mail delivery in small apartment communities for decades. Vertical mailboxes can be used for Postal Delivery *only* when they replace older vertical mailboxes for one-to-one replacement purposes. Over the years, postal regulations have changed and these mailboxes are no longer approved for new construction. As these units are top-loading, they should be protected from the weather.



[florencemailboxes.com/vertical](http://florencemailboxes.com/vertical)

## Standard Features

- Top-load
- Recessed- or surface-mounted
- Prepared for USPS installed Master Lock
- Mailbox all aluminum construction with anodized aluminum finish
- Surface callar all steel construction with silver powder coat finish
- 5-pin cylinder cam locks with two keys (*1,000 key changes*)
- Name and number ID card holders

## Optional Features

- Private master lock

## Door Size

The 1250 vertical series mailbox is pre-configured with one door size.

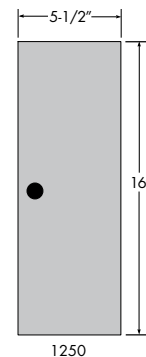

## Lock Option

The 1250 vertical series comes standard with a K30809 lock.





# Vertical Mailboxes



1250-3HA



1250-4HA



1250-5HA



1250-6HA



1250-7HA

**VERTICAL MAILBOX  
ALL CABINETS: 19-1/8" H 6-1/8" D**

Single Row	Double Row	Layout Per Row	Wall Cut Width	Overall Width
3	6	3	17-1/2"	19"
4	8	4	23"	24-1/2"
5	10	5	28-5/8"	30-1/8"
6	12	6	34-1/8"	35-5/8"
7	14	7	39-5/8"	41-1/8"
8	16	4-4	47-1/2"	49"
9	18	5-4	53-1/8"	54-5/8"
10	20	5-5	58-3/4"	60-1/4"
11	22	6-5	64-1/4"	65-3/4"
12	24	6-6	69-3/4"	71-1/4"
13	26	7-6	75-1/4"	76-3/4"
14	28	7-7	80-3/4"	82-1/4"
15	30	5-5-5	88-7/8"	90-3/8"
16	32	5-6-5	94-3/8"	95-7/8"
17	34	6-6-5	99-7/8"	101-3/8"
18	36	6-6-6	105-3/8"	106-7/8"
19	38	6-6-7	110-7/8"	112-3/8"
20	40	7-7-6	116-3/8"	117-7/8"
21	42	7-7-7	121-7/8"	123-3/8"
22	44	6-6-6-4	129-7/8"	131-3/8"
23	46	6-6-6-5	135-1/2"	137"
24	48	6-6-6-6	141"	142-1/2"
25	50	7-6-6-6	146-1/2"	148"
26	52	7-7-7-5	152"	153-1/2"
27	54	7-7-7-6	157-1/2"	159"
28	56	7-7-7-7	163"	164-1/2"
29	58	6-6-6-6-5	171-1/8"	172-5/8"
30	60	6-6-6-6-6	176-5/8"	178-1/8"

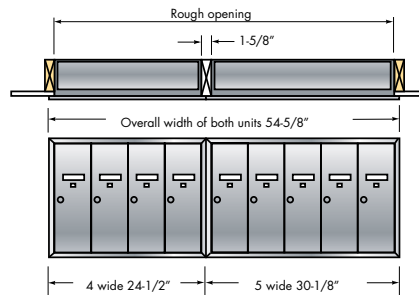
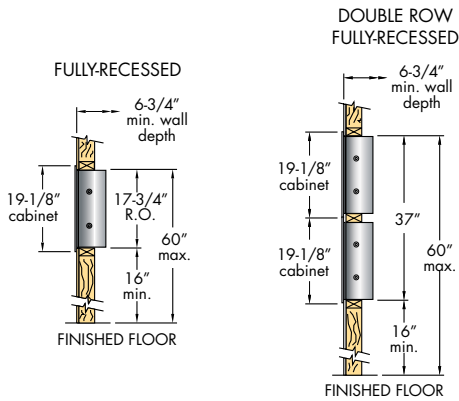

**Single Row**  
Wall Cut Depth = 6-3/4"  
Wall Cut Height = 17-3/4"  
Overall Height = 19-1/8"

**Double Row**  
Wall Cut Depth = 6-3/4"  
Wall Cut Height = 37"  
Overall Height = 38-1/4"

Note: Vertical mailbox installations should always be protected from direct exposure to the weather. Florence Corporation is not responsible for damage caused by weather conditions.

## Surface-Mount Collar

When your mailbox installation location has limited wall depth or walls that are covered in material which makes it difficult to cut a rough opening, the 1250 vertical series has a surface-mount collar option. This collar provides a sleek, finished look for the mailbox.



**VERTICAL MAILBOX MODEL NUMBERS**

Number of Compartments	Surface Mount Model Number
3	12503SMSHA
4	12504SMSHA
5	12505SMSHA
6	12506SMSHA
7	12507SMSHA



## SURFACE MOUNTED

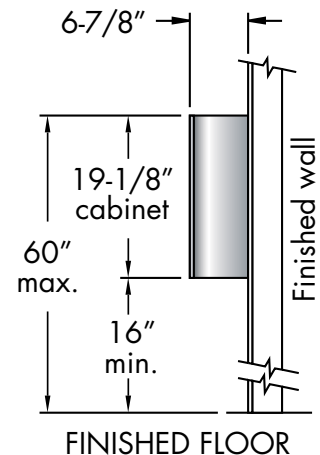

# FLORENCE CORPORATION

Call us Today Toll-free  
**800.229.2884**

Visit Us Online for More Info  
**WWW.AUTHENTICPARTS.COM**



## Powering Your Commercial and Residential Centralized Mailbox Designs for Over 80 Years!

Florence Corporation. Established. Dependable. Strong.

Like all great stories, ours started in a garage. Elbow grease, a sweaty brow. It's that kind of story. More than 80 years later, we're still hard at it; continually perfecting our craft, allowing you to perfect yours. You may take our products for granted. We take that as a compliment. Our products don't require attention or fuss. They're built smart, designed to work, and engineered to last.

We empower our customers with the products, the support, and the tools to design faster. Build smarter. Manage better. We understand that in a world of global commerce, demands of efficiency and last minute deadlines, you need a partner that can keep pace. You've met your match with Florence. Established. Dependable. Strong. It's not just what we make...it's what makes us.